



Rolling shutters in aluminium or steel

Synthesis of functionality and flexibility



Novoferm dotterbolag och produktionsanläggningar

- produktionsplatsen
- Försäljnings kontor

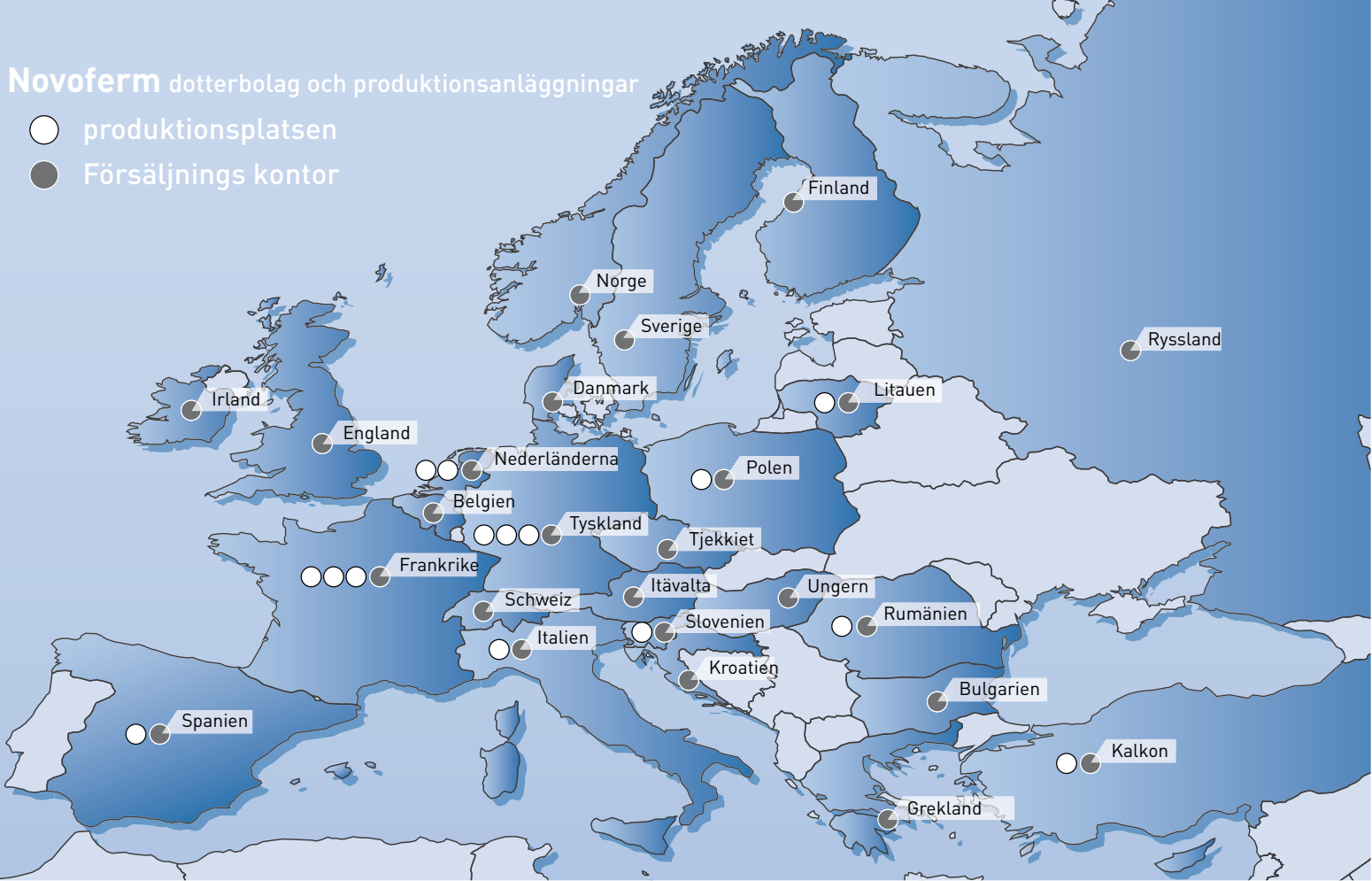

Novoferm International

Novoferm is part of the Sanwa Group. Founded in 1956, now with annual sales in over 60 countries totalling more than € 2 billion and with more than 8,700 employees, Sanwa is the world's largest producer of metal door systems. Sanwa provides everything from: industrial doors, fire protection doors, garage doors, roller shutters and automation. Our products are used around the world in industrial, commercial and residential applications.

For over thirty years Novoferm has specialised in many forms of access systems for industrial, commercial and residential buildings. With a wide choice of different designs, finishes, operation and

installation possibilities you get a bespoke solution every time. We take care of the complete process from technical advice to solution development, production, assembly and support on site. All aspects of the project including complete compliance with all relevant standards and legislation are always kept sharply in focus, which saves you a great deal of work.

In addition to industrial doors, draught excluding and fire-excluding doors, Novoferm has a full range of Dock Equipment. Our modern dock levellers and shelters guarantee efficient and draught-free loading and unloading of freight vehicles.

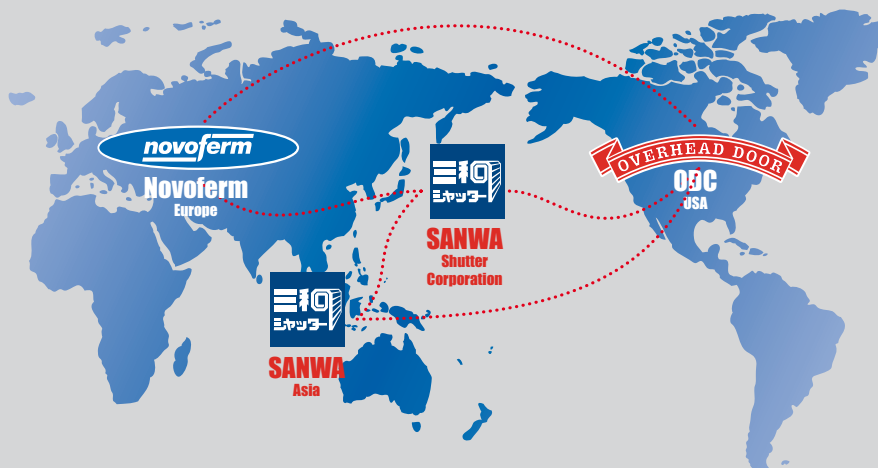

Rolling shutters

in aluminium or steel



Individual and universal

Our rolling shutters can be supplied in standard sizes or special sizes to suit your specific needs. All products supplied conform to the latest directives and standards.

The elegant profile design of the aluminium shutters makes your rolling shutter the calling-card of your premises. Painted surfaces are also available on request

Security tested

All our rolling shutters have the necessary certifications and have been security tested to most standard sizes.

Included within these tests, are the direct drives with integrated fail-safe devices which is an important section of the standards to which our doors fully comply.

Security tested | Individual and universal

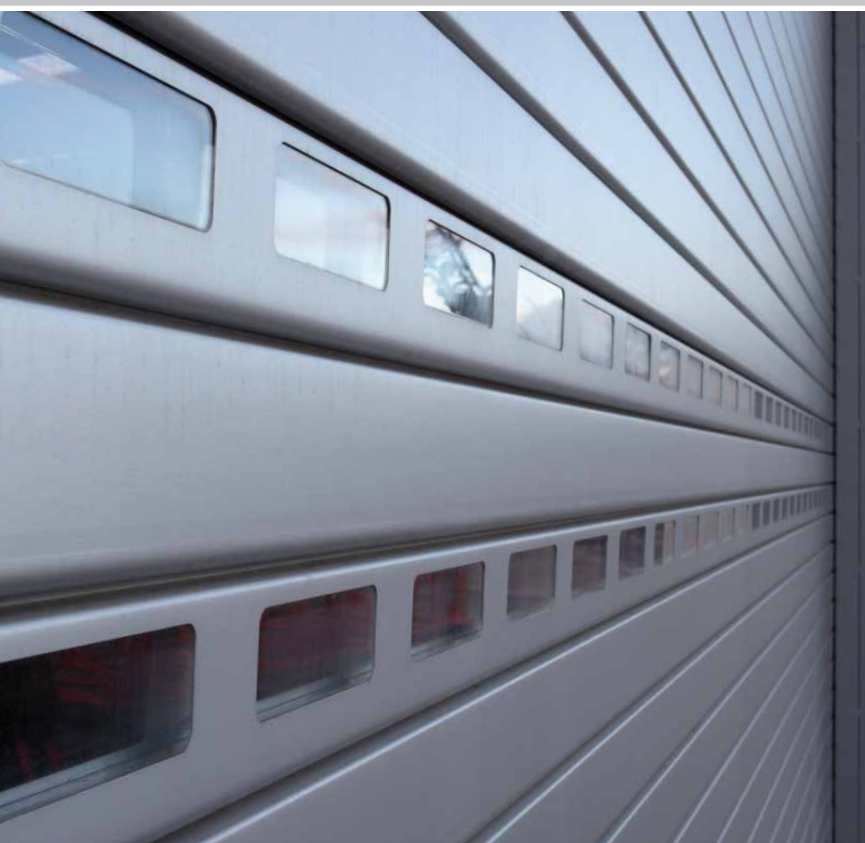

European safety and security standards

In accordance with the European EN 13241 standard, industrial doors must meet a large number of safety requirements. These focus on preventing that people and goods should not suffer injury or damage when the door is used. The risk of being trapped must be limited to a minimum and a door may not suddenly free fall because a cable or spring has broken or because the motor or controls have failed.

Novoform develops and produces the doors in strict compliance with these standards. Needless to say, we can provide the relevant certificates and test reports.

Rolling shutters

Type overview



TH100 Rolling shutter

Double skinned thermally insulated profile in **Natural aluminium** as standard. Also available with window profiles.

Aluminium end profile natural-untreated.

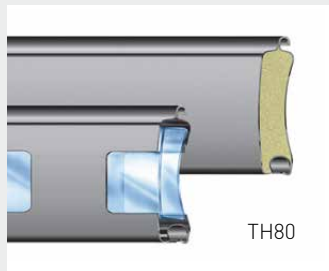

TH80 Rolling shutter

Double skinned thermally insulated profile in **Natural aluminium** as standard. Also available with window profiles.

Aluminium end profile natural-untreated.

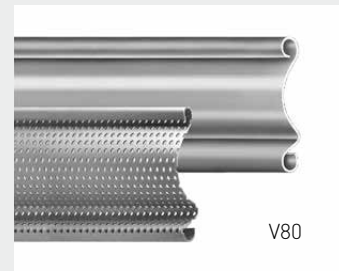

V80 and V80 L Rolling shutter

single skin profile in **natural aluminium** or **galvanized steel** as standard.

Aluminium end profile natural-untreated.

Rolling shutter curtain

The profiles are produced with inter connecting hinge quirk sections (for greater detail see page 6 & 7), these sections have a water-draining performance. The roller shutter curtain is fixed to the drum. All floor seals have

a good degree of flexibility to compensate for irregular floor levels. **TH80** and **TH100** profiles are secured against displacement/lateral movement by the inclusion of end locks, **V80** profiles are secured in the hinge area.

Technical details



Direct drive (standard):

Low maintenance, completely oilsealed, encased safety worm-drive, attached directly to the steel shaft of the drum, with clearly reduced installation and maintenance effort compared to other alternatives.

Integrated fail-safe catching device, low maintenance, self-checking and independent of position, as well as an encased limit-switch unit flanged directly onto the gear, with digital limit switches.

Emergency manual crank or fast-action hand-operated chain-hoist for manual closing in case of power failure. All electric connections can be plugged into the drive. Operating voltage 400 V three-phase a.c. current. TÜV & VDE tested.

Rolling shutters

Guide rails / Bottom beams / Sealing

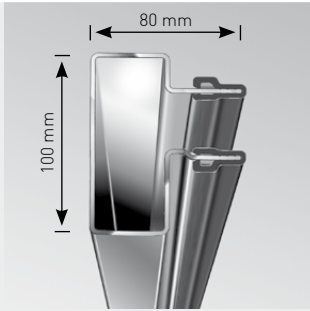

FS2 guide rail

For all our rolling shutters

Guide rail of galvanized steel, with attached plastic strips, also with side sealing, possible installation methods: welding or without welding using steel connectors.



Side seal for FS2 guide rail

Countering heat loss and draught, plastic strips provided on shutter inner side with brush seal.



<< End profile TH80

for rolling shutters TH80 made of aluminium, extruded, with permanently elastic weather seal.

End profile TH100 >>

for rolling shutters TH100 made of aluminium, extruded, with permanently elastic weather seal.



Technical details

Drum construction

Primed steel construction, 168mm minimum drum for improved winding of the door curtain, with a 1/500 distortion along its length.

Drum bracket

This can be fixed using anchor bolts, screw through or welding. In the case of welding the bracket is fastened against the on-site steel under-structure or pre-installed anchor plates, according to our alignment plans.

Self-aligning ball bearing

Heavy-duty dimensioning for the connection of the drum, placement on brackets.

Emergency control

from floor level, with emergency hand-operated chain-hoist.

Installation / Electrical installation:

Our installation conditions are coordinated to the main existing standards. According to these, the installation and connection of all electric parts, in accordance with our circuit diagrams, as well as the power supply and wiring system of the parts with respect to each other with the necessary lines, are services provided on-site.

Main fusing and lockable main power switch normally provided by the customer, can also be installed.

Note:

The following alternative is also available:

- Electrical drive for alternating current, 230 V operating voltage

Rolling shutters

Type summary and description



The NovoSpeed **Alu R** is a high-speed exterior door with TH80 profiles that offers good insulation and burglar resistance.

Specifications

NovoSpeed	Alu R
max. surface area (W x H)	25 m ²
max. width (W)	5000 mm
max. height (H)	5000 mm
opening speed	1 m/s
closing speed	0.5 m/s
slat height (visible)	80 mm
slat thickness	20 mm
slat material	anodised aluminium E6/EV1

Product Benefits

- class 2 wind resistance (EN 12424) up to a door size of 5 x 5 m.
- frequency control included as standard
- compact size for easy installation
- U-shaped side guides
- supplied in the following colours as standard:

9002

9006

9007

9010

7016

Alu R | TH100 | TH80 | V80

TH100 Natural aluminium



TH100

Micoline

100mm, double skinned lath

Aluminium lath. A conventional or Micoline profile section, approximately 23mm thick. With thermal-insulating polyurethane, non-plasticized foam core with adhesive-free connection with the shell, thus providing a high level of surface stability.

THGL100 Aluminium glazed

Aluminium lath with alternately mounted double glazed windows, double-walled plastic inserts (opaque), a maximum of 10 lath sections with windows per rolling shutter, Surfaces as TH100.

TH80 Natural aluminium

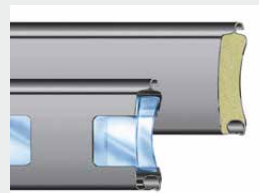

80mm, double skinned lath

Aluminium lath, approximately 20mm thick. With thermal-insulating polyurethane, non-plasticized foam core with adhesive-free connection to the shell, providing the highest level of surface stability. The especially developed profile section formed in high-quality optics, enables significantly tighter winding of the door curtain, allowing lower headroom requirements.

THGL80 Aluminium glazed

Aluminium lath with double glazed windows, double-walled plastic inserts (opaque), a maximum of 5 lath sections with windows per rolling shutter, Surfaces as TH80

V80 Natural aluminium or steel

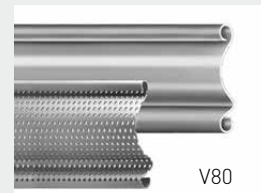

V80

Single-skinned 80 mm lath

with classic profile, available in two different metal structures: 1mm thick, weather-resistant, natural aluminium, or alternatively in 1 mm thick steel with galvanized surface.

V80 L steel

Single-skinned ventilation lath, available in steel only, 1 mm thick, with 5 mm perforations, allows approximately 25 % air passage.

Standard finish galvanized. End profile natural aluminium (untreated) as standard.

Rolling shutters

Colour options



Individual and exclusive

All Rolling shutters are available spray painted on one or both sides. This is an option at additional cost. Maximum door size 6000mm x 5000mm. All doors will have the bottom lath supplied in natural aluminium (untreated) as standard.

Also available in the following pre-coated colours as an option. The RAL colors shown below may vary from the actual RAL colors.



Profile sections are also available painted in a wide range of RAL colours.

9002

9006

9007

9010

7016

The finishing touch of your building



Rolling shutters

Operation

Direct drive



Deadmans control

The simplest control is what is commonly referred to as the deadman's control. The door will open after pressing the "Up" push button once. The "Down" push button must be constantly pressed to close the door until the door has completely closed. If your finger is removed at any time during closing, the door will stop.

Impulse control

The door will open fully after pressing the "Up" push button and the door will again close fully when the "Down" push button is pressed with regard to impulse control.

Automatic closing after an adjustable time delay setting

Automatic closing after an adjustable time delay setting is only possible in combination with a safety edge and safety beam protection in the doorway.

Expansions

- Remote control (up to 99 channels)
- Traffic regulation
- Interlocking on both sides with another door(s)
- External operation components such as radar, key switch, induction loop, etc.

Control



Available controls and accessories (at additional cost)



Push button set
Up-Stop-Down
(construction)



Manual transmitter
2 or 4 channels

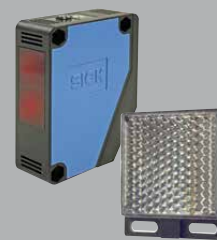

Safety photocell
with reflector



Up-Stop-Down push button set
Key switch
(construction)



Pull switches
(construction)



Induction loop detector
In separate housing



Push button
(construction)



Flashing light



Traffic light
Red/green

Rolling shutters

Installation examples and applications



Special structures

Available at additional cost. With our expertise, we also offer diverse and individual special solutions for unusual situations and special customer preferences.

Logistics companies

Rolling shutters traditionally guarantee secure and smooth work sequences in logistics companies.

Rolling shutters

Installation examples

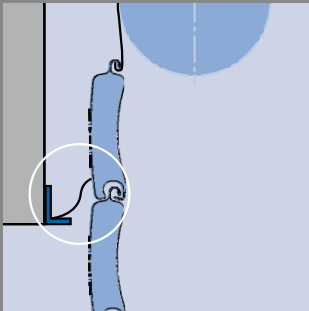

Lintel seal for TH80
countering heat loss and draught: through TH80 louvre with fixed integrated plastic seal.

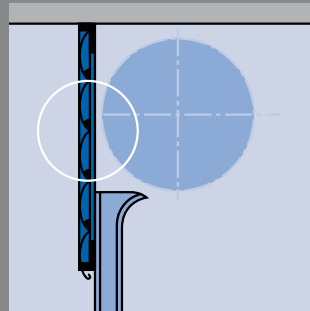

Horizontal facia panel
required when lintel is set back. Stationary panel, made of bent galvanised steel plate, according to shutter type either single-walled or insulated.

Improved security and useability



Burglary protection
Protects against the lifting of the shutter curtain, with lock cylinder, hand-grip, side locking bars and electronic safety switch included for on-site installation.



Accident prevention contact strip
A contact strip is fitted within the bottom rubber profile of the curtain, this causes an instant stop if the closing shutter encounters an obstacle; then the shutter door opens to relieve the impact pressure. This is generally included in case of automatically operated shutters, otherwise on request.







Automatic servo lock
Bolts engage automatically on both sides every time the door is closed. The rolling shutter curtain is securely locked into the door frame by laterally extending steel bolts. (Not possible on rolling grilles.)



Roll-off safety
The drive has a built-in roll-off safety. When a failure in the drive would occur, the Roll-off safety system is activated automatically. This ensures that the door can never close unintentionally.

Rolling shutters

Overview

Shutter type / Description		Speed (approx. m/sec.)	Viewing window	Sealed against draught	Slide-up protection	Galvanized surface	Ventilation elements	Painted surface	Electromechanical drive	Safety device acc. to Acc. Prev. Reggs	Periodic tests required
Standard rolling shutters	 TH80 aluminium	0.20	◆	●	◆		◆	●	●	●	Equipment: ● = Standard ◆ = Option (partially combinable)
	 TH100 aluminium	0.20	◆	●	◆		◆	●	●	●	
	 V80 aluminium	0.20		●	◆			●	●	●	
	 V80 steel	0.20		●	◆	◆	◆	●	●	●	
Quick-action	 Alu R aluminium	1,0	◆	●	◆		◆	●	●	●	

One producer and one supplier

Novoferm does not just supply industrial doors but offers a full range of draught excluding products, multifunctional wicket doors, fire doors and dock equipment. A Novoferm quality product fits in every opening of a modern industrial building. Doing business with one partner has the following advantages:

- Only one point of contact for all products, installation, maintenance and after sales;
- Products that have been produced to match;
- Product delivery will take place in the correct order automatically;
- Engineers who are familiar with all products.

www.novoferm.com



Novoferm, always close by wherever you are in Europe.

The Novoferm Group is a leading manufacturer of industrial doors, pass doors, steel door frames and drives. We offer an extensive range of products to consumers and businesses. All of our products are designed and produced to the highest quality standards using state-of-the-art technology. We also guarantee optimal functionality and innovative design. Production takes place at several manufacturing sites in Europe and an extensive dealer network ensures that local support and advice are always available.

Your Novoferm distributor:



www.novoferm.com



Novoferm International
www.novoferm.com

